

Aesculap Power Systems

Catalogue 2014



Aesculap Power Systems

Aesculap Power Systems

Aesculap – pioneer in the field of surgical power systems.

Aesculap introduced its first surgical electric motor as early as 1904. Further important milestones followed in subsequent decades with the introduction of compressed-air systems in the 1960s, the further development of flexible cable electric motors in the 1970s, the introduction of battery-driven motors in the 1980s and the development of pneumatic and electric high speed systems in the 1990s.

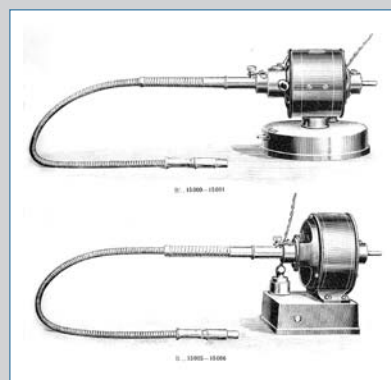
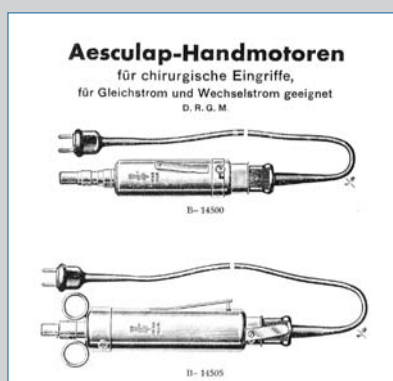

With the current systems Acculan 3Ti, HiLAN XS and microspeed uni, Aesculap offers you customized solutions for virtually all fields of application. Our system range is completed by the innovative storage system which enables timely, mechanical reprocessing of your Aesculap power systems.

Aesculap Power Systems

....get the speed you need.

How the catalogue works

1. Select motor system



GD675 **GB586R**

microspeed uni XS Hi
 High speed motor for all Hi-Line XS and Hi-Line XXS handpieces
 115 W; 10,000 – 80,000 rpm;
 ▲; 2.6 Ncm; 76 x 18 mm;
 80 g; Latex

●●●▶ Hi-Line XS, Hi-Line XXS

consisting parts:
 GB600820 Sterilit spray adaptor Hi
 GB600870 Sterilit spray adaptor XS

indicates handpiece compatibility

Electric

2. Select handpiece & fixation



GB756R **GB614R**

Hi-Line XS handpiece
 1 ring code;
 spray nozzle GB761SU (not included)

article code fixation

~ 40 mm

Hi-Line XS

3. Select Tool

Use Burrs & Blades catalogue 017599

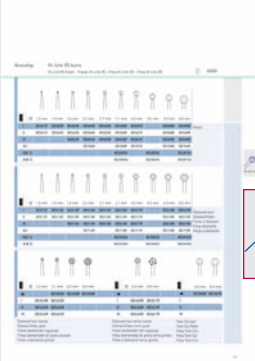
Aesculap® Burrs & Blades
 Catalogue 2013

2013

Chapter Hi-Line XS burrs

Hi-Line XS

Content

Power Systems

- Electric Power Systems
 - microspeed uni
 - microspeed arthro
 - Acculan 3Ti Electro
 - ELAN EC
- Pneumatic Power Systems
 - HiLAN XS
- Battery Power Systems
 - Acculan 3Ti

Handpieces

- Hi Hine XS, Hi-Line XXS
- micro-Line
- mini-Line

Accessories

Processing

- Sterilit Power Systems
- Mechanical Reprocessing

Index

Power Systems

Electric Power Systems

- microspeed uni
- microspeed arthro
- Acculan 3Ti Electro
- ELAN EC

Pneumatic Power Systems

- HiLAN XS

Battery Power Systems

- Acculan 3Ti

Electric Power Systems

microspeed uni



Electric power system for neurosurgery, neurotology and spine

- > Versatile system for small bone surgery and arthroscopy
- > Reliable and durable due to the application of top-grade material and state-of-the art technology
- > Easy operation over touch screen and function control button
- > Compatible with handpiece lines Hi-Line, Hi-Line XS, Hi-Line XXS, micro-Line and mini-Line

**GD670**

microspeed uni control unit
with irrigation pump; touch screen;
power cord not included;
pump flow 0 - 80 ml/min
100-240 V AC, 50/60Hz;
305 x 305 x 175 mm; 8,300 g
consisting parts:
GD412804 bottle holder

**GD668**

microspeed uni foot control
single pedal; protection type IPx8;
anaesthetic proof class M
↔; 5.0 m;
250 x 225 x 75 mm; 2,420 g

**GD671**

microspeed uni foot control
double pedal; protection type IPx8;
anaesthetic proof class M
↔; 5.0 m;
250 x 225 x 75 mm; 2,390 g

**GD672****GB689R**

microspeed uni motor cable
for use with motors GD674, GD676,
GD678, GD685
↔ 3.0 m; 360 g

**GD673****GB689R**

microspeed uni motor cable
with hand control; for use with
motors GD674, GD676, GD678,
GD685;
↔ 3.0 m; 380 g

**GD676****GB578R**

microspeed uni Hi 150
high speed motor for all Hi-Line
and Hi-Line XS handpieces
150 W; 10,000 - 80,000 rpm; ↔;
3.5 Ncm; 99 x 27 mm; 155 g
••► **Hi-Line, Hi-Line XS**
consisting parts:
GB600820 Sterilit spray adaptor Hi

microspeed uni



GD675

GB586R

microspeed uni XS Hi

high speed motor for all Hi-Line XS, Hi-Line XXS handpieces

115 W; 10,000 – 80,000 rpm; ↗↘; 2.6 Ncm; 76 x 18 mm; 80 g

...► Hi-Line XS, Hi-Line XXS

consisting parts:

GB600820 Sterilit spray adaptor Hi
GB600870 Sterilit spray adaptor XS



GD685

GB587R

microspeed uni perforator driver

to use with cranial perforatos with Hudson shank

150 W; 800 – 1,200 rpm; ↗↘; 2.0 Nm; 155 x 41 mm; 530 g

consisting parts:

GB600820 Sterilit spray adaptor Hi



GD678

GB578R

microspeed uni micro 150

low speed motor for all micro-Line handpieces

150 W; 1,000 – 30,000 rpm; ↗↘; 7.0 Ncm; 113 x 27 mm; 161 g

...► micro-Line

consisting parts:

GB600810 Sterilit spray adaptor micro-Line
GB600820 Sterilit spray adaptor Hi



GD674

GB578R

microspeed uni mini 100

low speed motor for all mini-Line handpieces except of GB398R

100 W; 1,000 – 16,000 rpm; ↗↘; 7.0 Ncm; 95 x 27 mm; 176 g

...► mini-Line

consisting parts:

GB600820 Sterilit spray adaptor Hi
GB600830 Sterilit spray adaptor mini-Line



GD684

GB579R

microspeed uni pistol handpiece

low speed pistol for all mini-Line handpieces except of GB373R, GB374R;

oscillation and tapping mode
100 W; 1,000 – 16,000 rpm; ↗↘; 7.0 Ncm; 2.5 mm; 3.0 m; 95 x 27 x 120 mm; 480 g

...► mini-Line

consisting parts:

GB600830 Sterilit spray adaptor mini-Line
GD684225 K-wire guide



GD681

GB580R

microspeed uni shaver handpiece

with hand control; for Aesculap shaver tips; variable suction; automatic tip recognition; oscillation speed adjustable 0.3 – 2.0 seconds

100 W; 400 – 8,000 rpm; ↗↘; 3.0 m; 150 x 27 x 37 mm; 510 g

consisting parts:

GB600820 Sterilit spray adaptor Hi





GD682

GB580R

microspeed uni shaver handpiece

for Aesculap shaver tips; variable suction; automatic tip recognition; oscillation speed adjustable 0.3 - 2.0 seconds; to be used in combination with foot control GD671

100 W; 400 - 8,000 rpm;  ;  3.0 m; 150 x 27 x 37 mm;

 510 g

consisting parts:

GB600820 Sterilit spray adaptor Hi

Power cords, irrigation sets and trolleys see 'Accessories'

Electric Power Systems

microspeed arthro



Electric power system for arthroscopy and small bone surgery

- > Reliability and durability due to the application of top-grade material and state-of-the-art manufacturing technology
- > Shaver handpieces available with ergonomic two button hand control or with foot control
- > Compact and lightweight construction, with automatic tip recognition
- > Individual adjustment of oscillation frequency and acceleration and stopping characteristics
- > Large range shaver tips and burrs for excellent cutting and ablation performance

**GD665**

microspeed arthro control unit
touch screen; power cord not included
100-240 V AC, 50/60Hz;
305 x 305 x 175 mm; 5,300 g

**GD671**

microspeed uni foot control
double pedal; protection type IPx8;
anaesthetic proof class M
5.0 m;
250 x 225 x 75 mm; 2,390 g

**GD672****GB689R**

microspeed uni motor cable
for use with motors GD674, GD676,
GD678, GD685
3.0 m; 360 g

**GD673****GB689R**

microspeed uni motor cable
with hand control; for use with
motors GD674, GD676, GD678,
GD685;
3.0 m; 380 g

**GD681****GB580R**

microspeed uni shaver handpiece
with hand control; for Aesculap
shaver tips; variable suction;
automatic tip recognition;
oscillation speed adjustable 0.3 -
2.0 seconds
100 W; 400 - 8,000 rpm; 3.0 m;
150 x 27 x 37 mm;
510 g
consisting parts:
GB600820 Sterilit spray adaptor Hi

**GD682****GB580R**

microspeed uni shaver handpiece
for Aesculap shaver tips; variable
suction; automatic tip recognition;
oscillation speed adjustable 0.3 -
2.0 seconds; to be used in
combination with foot control
GD671
100 W; 400 - 8,000 rpm; 3.0 m;
150 x 27 x 37 mm;
510 g
consisting parts:
GB600820 Sterilit spray adaptor Hi

microspeed arthro



GD684

GB579R

microspeed uni pistol handpiece

low speed pistol for all mini-Line handpieces except of GB373R, GB374R; oscillation and tapping mode 100 W; 1,000 - 16,000 rpm; ↔↔; 7.0 Ncm; ⚙️ 2.5 mm; 🌀 3.0 m; 95 x 27 x 120 mm; 📖 480 g

...▶️ mini-Line

consisting parts:
GB600830 Sterilit spray adaptor mini-Line
GD684225 K-wire guide



GD678

GB578R

microspeed uni micro 150

low speed motor for all micro-Line handpieces 150 W; 1,000 - 30,000 rpm; ↔↔; 7.0 Ncm; 113 x 27 mm; 📖 161 g

...▶️ micro-Line

consisting parts:
GB600810 Sterilit spray adaptor micro-Line
GB600820 Sterilit spray adaptor Hi



GD674

GB578R

microspeed uni mini 100

low speed motor for all mini-Line handpieces except of GB398R 100 W; 1,000 - 16,000 rpm; ↔↔; 7.0 Ncm; 95 x 27 mm; 📖 176 g

...▶️ mini-Line

consisting parts:
GB600820 Sterilit spray adaptor Hi
GB600830 Sterilit spray adaptor mini-Line

Power cords, irrigation sets and trolleys see 'Accessories'

Electric Power Systems

Acculan 3Ti Electro



Electric power system for orthopaedics, traumatology, cardiothoracic surgery, and dermatology

- > Powerful - up to 250 W
- > Reliable
- > Easy handling - Titanium housing allows mechanical alkaline reprocessing



GA871

GB495R

Acculan 3Ti Electro small drill
with oscillation and tapping mode
250 W; 4.0 mm;
107 x 47 x 180 mm; 1,100 g
consisting parts:
GA875 lid
GA876 adapter
GA678 sterile funnel
GA672211 rinsing adaptor
GA672207 K-wire protection sleeve



GA873

GB495R

Acculan 3Ti Electro oscillating saw
250 W; 0 - 15,000 1/min;
 4°47'; 107 x 47 x 200 mm;
 1,600 g
consisting parts:
GA875 lid
GA876 adapter
GA678 sterile funnel



GA874

GB495R

Acculan 3Ti Electro reciprocating saw
250 W; 0 - 15,000 1/min;
‡ 3.2 mm; 180 x 47 x 200 mm;
 1,540 g
consisting parts:
GA674890 cleaning adaptor
GA875 lid
GA876 adapter
GA678 sterile funnel
GB440215 cleaning plate



GB436R

GB686R

Protection guide
for use with GA674, GA874 and
saw blade GC761R



GA870

GB498R

Acculan 3Ti Electro dermatome
width keyless adjustable; thickness
adjustable (1/10 mm steps);
cutting thickness: 0.2 - 1.2 mm;
cutting width: max. 78 mm;
suitable blades GB228R (to be
ordered separately)
250 W; 0 - 6,500 1/min;
‡ 3.1 mm; 290 x 110 x 90 mm;
 1,700 g
consisting parts:
GA678 sterile funnel
GA875 lid
GA876 adapter



GA877

Acculan 3Ti Electro console
power cord not included
100-240 V AC, 50/60Hz;
255 x 217 x 90 mm; 2,930 g

Acculan 3Ti Electro



GA878

GB486R

Acculan 3Ti Electro connection cable
for use with GA870, GA871, GA873, GA874
3.0 m; 410 g



GA875

GB485R

Acculan 3Ti Electro lid



GA876

Acculan 3Ti Electro adapter
120 x 49 x 42 mm; 165 g



GA678

GB488R

Acculan 3Ti sterile funnel

Electric Power Systems

ELAN EC



Universal power system for all disciplines

- > Unlimited power
- > Legendary reliability and durability
- > Easy handling
- > More than 15.000 systems installed worldwide

**GA830****ELAN EC control unit**

power cord not included
 100-240 V AC, 50/60Hz;
 305 x 305 x 125 mm; 7,300 g

**GA835****ELAN EC control unit**

with irrigation pump; power cord not included;
 pump flow 0 - 80 ml/min
 100-240 V AC, 50/60Hz;
 305 x 305 x 125 mm; 7,900 g
 consisting parts:
 GD412804 bottle holder

**GA188****Foot control**

waterproof (IP67) acc. to IEC601 and DIN40050; anaesthetic proof class M
 5.0 m;
 130 x 200 x 60 mm; 1,900 g

**GA176****GB680R****Flexible cable micro**

for all micro-Line handpieces
 0 - 20,000 rpm; 1.8 m;
 600 g

...▶ micro-Line

GA173**GB680R****Flexible cable micro**

for all micro-Line handpieces
 0 - 20,000 rpm; 2.3 m;
 700 g

...▶ micro-Line

Power cords, irrigation sets and trolleys see 'Accessories'

Pneumatic Power Systems

HiLAN XS



Power, reliability and flexibility

- > HiLAN XS, HiLAN, microLAN - Integration of high and low speed
- > The pneumatic system for all applications in microsurgery

Recommended pressure for all pneumatic Aesculap Systems is 6-10 bar, 85-145 psi (technical information at 6 bar).

HiLAN XS



GA740R

GB610R

HiLAN XS

pneumatic high speed motor for all Hi-Line XS, Hi-Line XXS handpieces
50 W; 0 - 90,000 rpm; \curvearrowright ; 2.5 Ncm;
66 x 16 mm; \boxplus 63 g

...► **Hi-Line XS, Hi-Line XXS**

consisting parts:
GB600820 Sterilit spray adaptor Hi

HiLAN

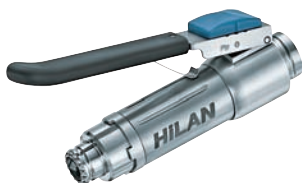

GA529

GB559R

HiLAN with hand control

pneumatic high speed motor for all Hi-Line and Hi-Line XS handpieces
50 W; 0 - 90,000 rpm; \curvearrowright ; 2.5 Ncm;
80 x 19 mm; \boxplus 132 g

...► **Hi-Line, Hi-Line XS**

consisting parts:
GB600820 Sterilit spray adaptor Hi

GA742R

GB609R

HiLAN perforator driver

with Hudson chuck
130 W; 0 - 800 rpm; \curvearrowright ; 3.6 Nm;
130 x 37 mm; \boxplus 495 g

consisting parts:
GB600820 Sterilit spray adaptor Hi



microLAN



GA553

GB685R

microLAN 100

pneumatic motor for all micro-Line handpieces except of GB169R, GB265R, GB268R
100 W; 0 - 20,000 rpm; \curvearrowright ; \curvearrowright ;
8.0 Ncm; 95 x 22 mm; \boxplus 130 g

...► **micro-Line**

consisting parts:
GB600810 Sterilit spray adaptor micro-Line
GB600820 Sterilit spray adaptor Hi

Battery Power Systems

Acculan 3Ti



Acculan 3Ti is the battery-operated power system for orthopaedics, traumatology, cardiothoracic surgery, and dermatology

- > Powerful – up to 250 Watt
- > Reliable – battery and control electronic are not sterilised
- > Easy handling – Titanium housing allows mechanical alkaline reprocessing

Acculan 3Ti – the reinvention of battery power tools



GA671

GB495R

Acculan 3Ti small drill

with oscillation and tapping mode;
not for use with Acetabulum
reamers

220 W; 4.0 mm;
107 x 47 x 180 mm; 1,100 g

consisting parts:

GA666 small NiMH battery

GA675 lid

GA678 sterile funnel

GA672207 K-wire protection sleeve

GA672211 rinsing adaptor

GB600840 Sterilit spray adaptor

Acculan 3Ti



GA672

GB495R

Acculan 3Ti drill and reamer

250 W; 4.0 mm;
107 x 47 x 200 mm; 1,250 g

consisting parts:

GA675 lid

GA676 NiMH battery

GA678 sterile funnel

GA672207 K-wire protection sleeve

GA672211 rinsing adaptor

GB600840 Sterilit spray adaptor

Acculan 3Ti



GB635R

GB496R

Acculan 3Ti drill attachment

with small AO chuck

0 - 1,000 rpm; 5.0 Nm;

4.0 mm; 90 x 39 mm; 246 g



GB636R

GB496R

Acculan 3Ti drill attachment

with Aesculap hexagonal chuck

0 - 1,000 rpm; 5.0 Nm;

4.0 mm; 93 x 39 mm; 253 g



GB630R

GB496R

Acculan 3Ti drill attachment

with Zimmer/Hudson chuck

0 - 1,000 rpm; 5.0 Nm;

4.0 mm; 100 x 39 mm; 263 g



GB637R

GB496R

Acculan 3Ti drill attachment

with trinkle chuck

0 - 1,000 rpm; 5.0 Nm;

4.0 mm; 93 x 39 mm; 250 g

Acculan 3Ti



GB638R

GB496R

Acculan 3Ti drill attachment
with Jacobs chuck 0.6 - 7.4 mm
0 - 1,000 rpm; 5.0 Nm;
4.0 mm; 110 x 39 mm; 333 g
consisting parts:
GA031201 key



GB634R

GB496R

Acculan 3Ti drill attachment
with Jacobs chuck keyless 0.6 -
7.4 mm
0 - 1,000 rpm; 5.0 Nm;
4.0 mm; 125 x 39 mm; 430 g



GB643R

GB496R

Acculan 3Ti K-wire attachment
for K-wires from 0.6 to 4.0 mm
0 - 1,000 rpm; 93 x 36 x 137 mm;
300 g



GB645R

GB496R

Acculan 3Ti drill attachment
for Synthes radiolucent drive
511.300
0 - 900 rpm; 110 x 35 mm; 225 g

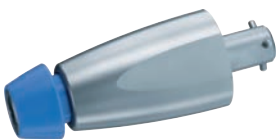

GB654R

GB496R

Acculan 3Ti reamer attachment
with Harris chuck
0 - 250 rpm; 19.0 Nm;
4.0 mm; 106 x 39 mm; 323 g



GB655R

GB496R

Acculan 3Ti reamer attachment
with large AO chuck
0 - 250 rpm; 19.0 Nm;
4.0 mm; 107 x 39 mm; 334 g



GB656R

GB496R

Acculan 3Ti reamer attachment

with Zimmer/Hudson chuck
0 - 250 rpm; 19.0 Nm;
4.0 mm; 118 x 39 mm; 344 g



GB658R

GB496R

Acculan 3Ti drill attachment

with Jacobs chuck 0.6 - 7.4 mm
0 - 250 rpm; 19.0 Nm;
4.0 mm; 118 x 39 mm; 416 g
consisting parts:
GA031201 key



GB660R

GB496R

Acculan 3Ti sagittal saw attachment

for Acculan 3Ti rapid action saw blades with a maximum useable length of 50 mm
0 - 17,000 1/min; 4°47';
89 x 36 x 44 mm; 270 g



GA673

GB495R

Acculan 3Ti oscillating saw

250 W; 0 - 15,000 1/min;
4°47'; 107 x 47 x 200 mm;
1,600 g
consisting parts:
GA675 lid
GA676 NiMH battery
GA678 sterile funnel



GA668

GB498R

Acculan 3Ti straight oscillating saw

250 W; 0 - 15,000 1/min;
4°47'; 288 x 54 x 74 mm;
1,500 g
consisting parts:
GA675 lid
GA676 NiMH battery
GA678 sterile funnel

Acculan 3Ti



GA674

GB495R

Acculan 3Ti reciprocating saw

250 W; «↔» 0 - 15,000 1/min;
 † 3.2 mm; 180 x 47 x 200 mm;
 ⚖ 1,540 g
 consisting parts:
 GA674890 cleaning adaptor
 GA675 lid
 GA676 NiMH battery
 GA678 sterile funnel
 GB440215 cleaning plate



GB436R

GB686R

Protection guide

for use with GA674, GA874 and
 saw blade GC761R



GA670

GB498R

Acculan 3Ti dermatome

width keyless adjustable; thickness
 adjustable (1/10 mm steps);
 cutting thickness: 0.2 - 1.2 mm;
 cutting width: max. 78 mm;
 suitable blades GB228R (to be
 ordered separately)
 220 W; «↔» 0 - 6,500 1/min;
 † 3.1 mm; 290 x 110 x 90 mm;
 ⚖ 1,700 g
 consisting parts:
 GA666 small NiMH battery
 GA675 lid
 GA678 sterile funnel



GA677

Acculan 3Ti charger

for Acculan 3Ti batteries
 GA666 and GA676; 4 charging
 bays; avoids memory effect;
 automatic battery diagnosis
 function; with optional available
 charging bay GA677830 also
 compatible to Acculan II batteries
 GA616, GA626 and GA646; power
 cord not included
 100-240 V AC, 50/60Hz;
 440 x 140 x 180 mm; ⚖ 3,500 g



GA666

Acculan 3Ti small NiMH battery
only for GA670 and GA671; with
integrated electronic motor control
9.6V ; 1.05Ah
120 x 43 x 50 mm;  304 g



GA676

Acculan 3Ti NiMH battery
only for GA668, GA672, GA673,
GA674; with integrated electronic
motor control
9.6V ; 1.95Ah
140 x 43 x 50 mm;  425 g

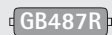

GA675

 **GB487R**

Acculan 3Ti lid



GA678

 **GB488R**

Acculan 3Ti sterile funnel

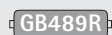

GA679

 **GB489R**

**Acculan 3Ti battery removal
device**

Handpieces

Hi-Line XS, Hi-Line XXS

micro-Line

mini-Line

Hi-Line XS, Hi-Line XXS

Straight Hi-Line XS handpieces for the Hi-Line XS burr range



GB751R

GB614R

Hi-Line XS handpiece, straight

1 ring code;
spray nozzle GB761SU (not included)

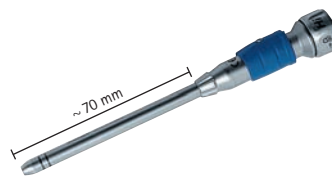

GB752R

GB614R

Hi-Line XS handpiece, straight

2 ring code;
spray nozzle GB762SU (not included)

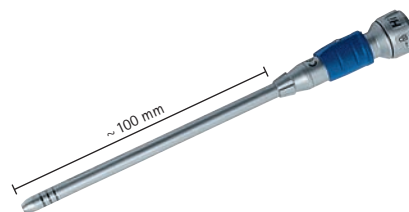

GB753R

GB614R

Hi-Line XS handpiece, straight

3 ring code;
spray nozzle GB763SU (not included)

Angled Hi-Line XS handpieces for the Hi-Line XS burr range



GB756R

GB614R

Hi-Line XS handpiece, angled

1 ring code;
spray nozzle GB761SU (not included)



GB757R

GB614R

Hi-Line XS handpiece, angled

2 ring code;
spray nozzle GB762SU (not included)

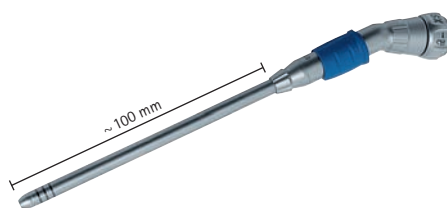

GB758R

GB614R

Hi-Line XS handpiece, angled

3 ring code;
spray nozzle GB763SU (not included)

Hi-Line XS, Hi-Line XXS

Angled Hi-Line XS handpieces for the Hi-Line XS burr range

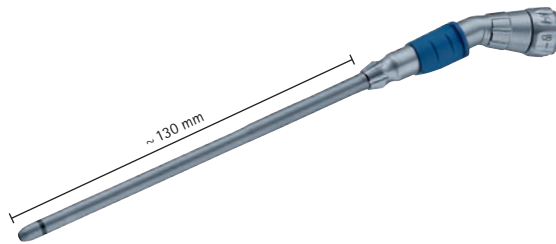

GB771R

GB614R

Hi-Line XS handpiece, angled
extra long XL1;
1 bold ring code;
spray nozzle GB764SU (not
included)

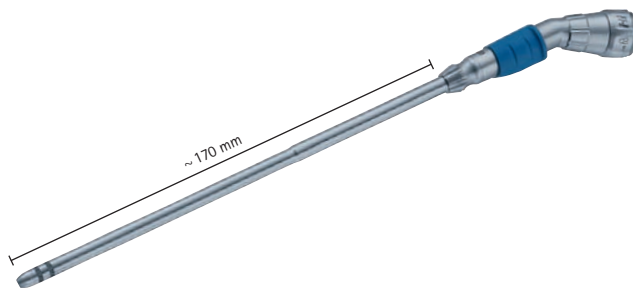

GB772R

GB614R

Hi-Line XS handpiece, angled
extra long XL2;
2 bold ring code;
spray nozzle GB765SU (not
included)

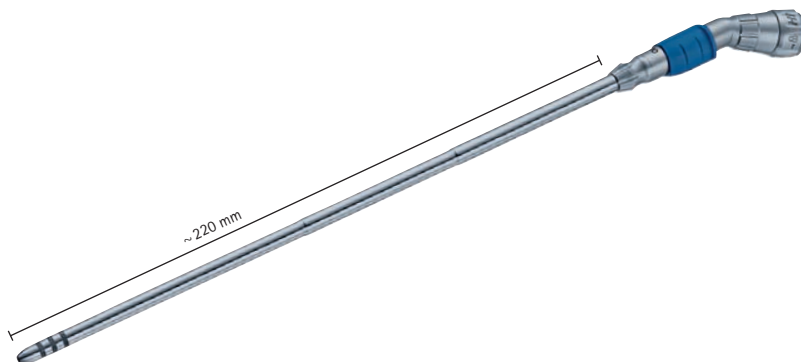

GB773R

GB614R

Hi-Line XS handpiece, angled
extra long XL3;
3 bold ring code;
spray nozzle GB766SU (not
included)

Craniotome and multipurpose handpiece



GB740R

GB614R

Hi-Line XS craniotome and multi purpose handpiece

to be used with dura guards, drill depth guard and holding sleeve GB741R - GB748R, spray nozzle GB767SU (not included)



GB741R

GB615R

Hi-Line XS dura guard

fixed;
1 ring code;
to be used with craniotome burr GE420R, GE420SU, GE429SU



GB742R

GB615R

Hi-Line XS dura guard

fixed;
2 ring code;
to be used with craniotome burr GE520R, GE520SU, GE529SU



GB743R

GB615R

Hi-Line XS dura guard

fixed;
3 ring code;
to be used with craniotome burr GE620R, GE620SU, GE629SU

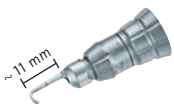

GB746R

GB615R

Hi-Line XS dura guard

steerable;
1 ring code;
to be used with craniotome burr GE420R, GE420SU, GE429SU



GB747R

GB615R

Hi-Line XS dura guard

steerable;
2 ring code;
to be used with craniotome burr GE520R, GE520SU, GE529SU

Hi-Line XS
Hi-Line XXS

Hi-Line XS, Hi-Line XXS

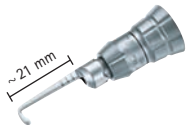

GB748R

GB615R

Hi-Line XS dura guard

steerable;
3 ring code;
to be used with craniotome burr
GE620R, GE620SU, GE629SU



GB744R

GB615R

Hi-Line XS drill depth guard

for craniotome handpiece and
multipurpose handpiece GB740R
2 - 8 mm



GB745R

GB615R

Hi-Line XS holding sleeve

for craniotome handpiece and
multipurpose handpiece GB740R

Handpiece for minimal-invasive approaches for the Hi-Line XXS burr range



GB790R

GB605R

Hi-Line XXS handpiece
to be used with the handpiece shafts GB791R - GB794R



GB791R

GB606R

Hi-Line XXS handpiece shaft, straight

2 ring code
spray nozzle GB796SU (not included)



GB792R

GB606R

Hi-Line XXS handpiece shaft, curved

2 ring code
spray nozzle GB796SU (not included)



GB793R

GB606R

Hi-Line XXS handpiece shaft, straight

3 ring code
spray nozzle GB797SU (not included)



GB794R

GB606R

Hi-LineXXS handpiece shaft, curved

3 ring code
spray nozzle GB797SU (not included)

Hi-Line XS
Hi-Line XXS

micro-Line

For burrs with shank diameter of 2.35 mm



GB109

GB681R

micro-Line handpiece

coding: 1 blue ring;
for 51 mm burrs
1:1; 81 mm



GD450M

GB681R

micro-Line handpiece

coding: 1 blue ring;
for 70 mm burrs;
suitable spray nozzle GD460R (not
included)
1:1; 97 mm



GD451M

GB681R

micro-Line handpiece

coding: 1 blue ring;
for 95 mm burrs;
1:1; 127 mm

For burrs with shank diameter of 2,35 mm; angulation 21°



GD455M

GB681R

micro-Line handpiece, angled

coding: 1 red ring;
for 70 mm burrs;
suitable spray nozzle GD460R (not
included)
1:2; 120 mm



GD456M

GB681R

micro-Line handpiece, angled

coding: 1 red ring;
for 95 mm burrs;
1:2; 150 mm



GD457M

GB681R

micro-Line handpiece, angled

coding: 1 red ring;
for 125 mm burrs;
1:2; 180 mm

micro-Line

micro-Line

For use with micro-inserts with imperator gearing, angulation 21°



GB111

GB681R

micro-Line handpiece

coding: 1 green ring;
suitable spray nozzle GA227R (not included)
4:1; 74 mm



GB173

GB690R

Imperator attachment

for burrs with 2.35 mm diameter;
up to 70 mm length; minimal shaft
length 30 mm; spray nozzle
GA227R (not included)
1:1; 43 mm



GB164

Mounting tool

for imperator attachment GB173



GB119

GB690R

Contra angle head

coding: 1 green dot;
for tools with Dental shank
2:1; 43 mm



GD305

GB681R

micro-Line reciprocating saw

keyless; suitable spray nozzle
GD306R (not included)
2,5:1; \uparrow 1.3 mm; \boxplus 48 g
consisting parts:
GD320R saw blade



GD307

GB681R

micro-Line sagittal saw

with captive nut; suitable spray
nozzle GD308R (not included)
2,5:1; \angle 7°; \boxplus 50 g
consisting parts:
GD372206 key



GB129

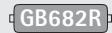

micro-Line sagittal saw
spray nozzle GA222R (not included)
1:1; \angle 4°46'; \bar{m} 345 g
consisting parts:
GB125804 nut
TE472 ring spanner



GB128R



micro-Line transversal saw
suitable spray nozzle GA221R (not included)
1:1; \angle 10°24'; \bar{m} 385 g
consisting parts:
GB020R allen key



GB130R



micro-Line reciprocating saw
suitable spray nozzle GA223R (not included)
1:1; \ddagger 3.0 mm; \bar{m} 310 g
consisting parts:
TA004634 key



GB200



micro-Line drill pistol
spray nozzle GA221R (not included)
 \blacktriangleleft \blacktriangleright 20:1; \bar{m} 2.7 mm; \bar{m} 700 g



GB222

Jacobs chuck
 \varnothing 0 - 4 mm
consisting parts:
GA062R key



GB223

Jacobs chuck
 \varnothing 0 - 6.5 mm
consisting parts:
GA031R key

micro-Line



GB224
Small AO chuck



GB227R
K-wire driver
for K-wires from 0.6 to 2.5 mm



GB231R **GB682R**
micro-Line Dermatome acc. to Wagner
cutting width keyless adjustable;
thickness adjustable (1/10 mm steps);
cutting thickness: 0.2 - 1.2 mm;
cutting width: max. 78 mm
6:1; † 3.0 mm; ⚖ 770 g
consisting parts:
GB228R blades



GB169R **GB682R**
micro-Line drill
for exchangeable chucks; suitable
spray nozzle GA228R (not included)
20:1; ⚖ 280 g
consisting parts:
GC523200 ring spanner



GB106R
Hudson chuck
for GB169R



GB265R **GB682R**
micro-Line craniotome
with turnable duraguard
1:1; ⚖ 200 g
consisting parts:
GB266M turnable dura-guard
GB267R handpiece
GC303R burr



GB268R



micro-Line craniotome

with fixed duraguard

1:1; 200 g

consisting parts:

GB267R handpiece

GB298R fixed dura-guard

GC303R burr



GB292



**micro-Line pediatric craniotome,
Freiburg pattern**

with fixed duraguard

1:1; 100 g

consisting parts:

GB109 handpiece

GB291R dura-guard

GC304R burr

mini-Line



GB376R

GB673R

mini-Line burr attachment

straight; for 2,35 mm shank; for burrs up to 70 mm length; suitable spray nozzle GB378 (not included)
32,000 rpm; 1:2; 108 g



GB382R

GB673R

mini-Line drill attachment

for tools with AO shank; suitable spray nozzle GB378 (not included)
1,000 rpm; 16:1; 98 g



GB383R

GB673R

mini-Line drill attachment

Jacobs chuck; suitable spray nozzle GB378 (not included)
Ø 0 - 4 mm
1,000 rpm; 16:1; 2.5 mm;
160 g
consisting parts:
GA062R key



GB377R

GB674R

mini-Line heavy duty drill attachment

Jacobs chuck; suitable spray nozzle GB378 (not included)
Ø 0 - 6.5 mm
800 rpm; 36:1; 2.5 mm;
220 g
consisting parts:
GA031R key



GB373R

GB673R

mini-Line angled drill attachment

for tools with dental shank
2,000 rpm; 8:1; 91 g



GB398R

GB674R

mini-Line K-wire attachment

for use with GD684;
for K-wires from 0.6 to 2.5 mm
1,000 rpm; 16:1; 190 g



GB374R GB673R

mini-Line angled K-wire attachment

for use with straight mini motors;
for K-wires from 0.6 to 1.6 mm
900 rpm; 17:1; 120 g



GB390R GB673R

mini-Line sagittal saw attachment

16,000 rpm; 1:1; \angle 5°; 100 g



GB391R GB673R

mini-Line reciprocating saw attachment

16,000 rpm; 1:1; \downarrow 2.1 mm; 100 g



GB392R GB674R

mini-Line transversal saw attachment

16,000 rpm; 1:1; \angle 10°; 140 g



GA187R GB673R

micro-Line adaptor

handpiece: micro;
motor: mini

Accessories

Accessories for electric motors



GA411

microspeed uni mobile stand

adjustable height
I1200 - 1500 mm



GA415

Mobile stand

for ELAN, microspeed EC and
Microtron devices; adjustable
height
I1200 - 1500 mm



GD416M

Mobile stand

for AESCULAP control units
I1320 mm
consisting parts:
GD414R



GD412804

Bottle holder



TE780

Power cord Europe; black

 1.5 m

TE730

Power cord Europe; black

 5.0 m

TE734

Power cord UK; black

 5.0 m

TE735

**Power cord USA, Canada, Japan;
black**

 3.5 m

Accessories

Wall outlet	Motor inlet	Air hoses
-------------	-------------	-----------



AESCULAP Dräger



AESCULAP small

GA505R

GB564R

Air hose
 5.0 m

GA513R

GB564R

Air hose
 3.0 m

Wall outlet	Motor inlet
-------------	-------------



AESCULAP Dräger



AESCULAP small

GA523R

GB564R

Air hose
 (for irrigation pump GA530)
 2.3 m

Wall outlet	Motor inlet
-------------	-------------



DIN



AESCULAP small

GA507R

GB576R

Air hose
 5.0 m

Wall outlet

Motor inlet



Schrader with diffusor



AESCULAP small

GA506R

GB575R

Air hose

5.0 m

Wall outlet

Motor inlet



AESCULAP Dräger



AESCULAP large

GA464R

GB463R

Air hose

3.0 m

GA466R

Air hose

5.0 m

GA460R

GB463R

Air hose, spiral type

3.0 m

Recommended pressure for all pneumatic AESCULAP Systems is 6 - 10 bar, 85 - 145 psi
 Motor connection small fits: GA502, GA508R, GA519, GA520R, GA529, GA551, GA552, GA553, GA554, GA740R, GA741R, GA742R
 Motor connection large fits: GA200, GA430, GA437, GA440, GA521, GA530

Accessories

Wall outlet Motor inlet



DIN



AESCULAP large

GA463R

Air hose
 3.0 m

GA465R

Air hose
 5.0 m

Wall outlet Motor inlet



DIN with diffuser



AESCULAP large

GA461R

Air hose
 3.0 m

Wall outlet Motor inlet



Schrader with diffuser



AESCULAP large

GA468R

Air hose
 5.0 m

GB480R

Recommended pressure for all pneumatic AESCULAP Systems is 6 - 10 bar, 85 - 145 psi
 Motor connection small fits: GA502, GA508R, GA519, GA520R, GA529, GA551, GA552, GA553, GA554, GA740R, GA741R, GA742R
 Motor connection large fits: GA200, GA430, GA437, GA440, GA521, GA530

Wall outlet



AESCULAP Dräger

Motor inlet



AESCULAP Dräger

Extension hoses

GA194R

Extension hose

3.0 m

GA195R

Extension hose

5.0 m

Wall outlet



DIN

Motor inlet



DIN

GA087

Extension hose

5.0 m

Pneumatic accessories



GA521

Foot control

for pneumatic systems
air inlet: large
air outlet: AESCULAP Dräger



GA099

Air pressure reducer

air pressure reducer with DIN quick lock coupling; for compressed air cylinders acc. to DIN477 G5/8" AG; air inlet 100 - 200 bar / 2130-2840 psi
consisting parts:
GA088C DIN quick lock coupler

Accessories



GA088C

Quick lock coupler
for air pressure reducer GA099; for
DIN system



GA091C

Quick lock coupler
for french system



GA508R

Angled hose adaptor
for all small Aesculap motors



GA206R

GB474R

Adaptor for pneumatic systems
AESCULAP motor large - Synthes air
hoses



GA208

GB474R

Adaptor for pneumatic systems
Synthes motor - air hose with
Aesculap motor connector large

Irrigation



GA530

Irrigation pump

for pneumatic systems; to be used with tubing set GA391SU and GA526P (not included)
 pump flow 0- 80 ml/min
 100-240 V AC, 50/60Hz;
 305 x 305 x 135 mm; 5,500 g
 consisting parts:
 GD412804 bottle holder



GA391SU

Tubing Set

complete;
 including adaptor for spray nozzles, fixation clips and punch for irrigation bottle;
 for microspeed uni, Microspeed EC, Microtron EC, HiLAN (in connection with GA526P)
 ☒ package of 10 pieces



GA392SU

Tubing set with Y-Adaptor

complete;
 including adaptor for spray nozzles, fixations clips and punch for irrigation bottle;
 for microspeed uni
 ☒ package of 10 pieces

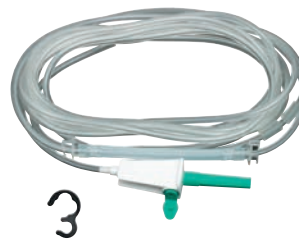

GA391

Tubing set

complete; including adaptor for spray nozzles, fixation clips and punch for irrigation bottle; for ELAN (micro and mini cable only); HiLAN in connection with GA526P
 ☒ package of 10 pieces



GA526P

Fixation clips

for combining tubing set GA391 or GA391SU with pneumatic motors
 ☒ package of 8 pieces

Accessories

Adaptor



GB421R

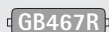

tool: Hudson;
motor: Harris
Ø 3.8 mm



GB422R

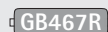

AO large adaptor
tool: AO large;
motor: Harris
Ø 3.8 mm



GB423R



DIN adaptor
tool: DIN;
motor: Harris
Ø 3.8 mm



GB425R

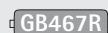

Zimmer/Hudson adaptor
tool: Zimmer/Hudson;
motor: Harris
Ø 3.8 mm



GB426R

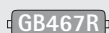

Jacobs chuck
tool: Jacobs;
motor: Harris
Ø 0,6 - 7,4 mm
Ø 3.8 mm



GB628R

Synthes DHS/DCS adaptor
tool: Synthes DHS/DCS;
motor: AO large
Ø 4.2 mm



GB182R



Harris adaptor
tool: Harris;
motor: Hudson
not canulated



GB184R



Harris adaptor
tool: Harris;
motor: AO large
3.5 mm



XF457R



DIN adaptor
tool: DIN;
motor: AO large
3.8 mm



GB007R

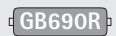

AO large adaptor
tool: AO large;
motor: DIN
4.0 mm



GB187R

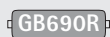

Harris adaptor
tool: Harris;
motor: triangle
3.5 mm



GA187R

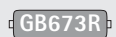

micro-Line adaptor
handpiece: micro;
motor: mini

Accessories

Keys



GA031R

GB690R

Key

for big Jacobs chuck
suitable for GB223R, GB386R,
GB416R, GB426R, GB424R,
GB177R, GB638R, GB658R



GA186209

GB690R

Key

for mini-coupling
suitable for GA186, GA551, GA552,
GA647, GD674, GD684

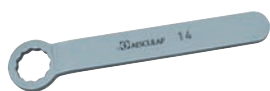

TE472

GB690R

Ring spanner

for Aesculap star coupling



GB020R

GB690R

Allen Key

suitable for GB101, GB102R,
GB115R, GB121R, GB125R, GB210R,
GB230R, GB377R



GA062R

GB690R

Key

for small 4mm Jacobs chuck
suitable for GB108R, GB166R,
GB181R, GB222R, GB383R, GB415R



GD372206

Key

width across flats 6,0 mm
suitable for GD307



GC523R

Ringspanner

suitable for GA522R, GB106R,
GB108R, GB169R

Skin graft mesher



BA720R

GB688R

Skin graft mesher

for use in combination with skin
carriers BA721 (1:1,5) /
BA722 (1:3) / BA723 (1:6)
150 x 195 x 105 mm; 4,600 g
consisting parts:
BA725R cutting roller
BA726R ratchet wrench



BA725R

Cutting roller

Cement injection



GB141

Cement syringe

for cement injector GB171N; with
special injection tubing
50 ml
Ⓢ; 10 package of 10 pieces



GB171N

Cement injector w. Harris shank
for disposable syringe GB141

Accessories

Bone mill



GB040

Bone mill

for use with motor or crank handle
consisting parts:
GB042R crushing drum



GB042R

GB042R

Crushing drum

standard; Harris shaft; section of
the produced bone chip
0.7 x 3 mm



Crushing drum

fine; Harris shaft; section of the
produced bone chip 0.7 x 2 mm

GB043R

GB043R

Crushing drum

coars; Harris shaft; section of the
produced bone chip 0.7 x 4 mm



GB041R

Crank handle for GB040



GB046

Insert for GB040
for small bone grafts



Processing

Sterilit Power Systems

Mechanical Reprocessing

Sterilit Power Systems

Sterilit Power Systems



GB600

Sterilit Power Systems
300 ml
📦 package of 6 pieces



GB600810

Sterilit Power Systems spray adaptor
for micro-Line



GB600820

Sterilit Power Systems spray adaptor
for HiLAN, HiLAN XS,
Hi-Line (XS, XXS), Microspeed EC,
microspeed uni, microLAN, miniLAN



GB600830

Sterilit Power Systems spray adaptor
for mini-Line



GB600840

Sterilit Power Systems spray adaptor
for Acculan 3Ti



GB600870

Sterilit Power Systems spray adaptor
for microspeed uni XS



GA059

Sterilit drip lubricator

50 ml

Mechanical Reprocessing

Mechanical Reprocessing

The solution for storage and mechanical reprocessing of your Aesculap Power Systems

Basic requirements for mechanical reprocessing in combination with our storage system:

- > A suitable cleaner must be used (pH < 11 for Aluminum components)
- > The temperature in the cleaning cycle must not exceed 60°C
- > Clean for at least 3 minutes
- > Apply intermediate rinse for at least 1 minute
- > Carry out intensive final rinse with distilled, demineralised or fully desalinated water
- > Only Thermal disinfection: 5 minutes rinse at max. 96°C with distilled, demineralised or fully desalinated water
- > Complete the programme with a drying phase of at least 10 minutes at a temperature of not more than 120°C

microspeed uni/microspeed arthro



GB579R

Fixation
for GD684
56 mm



GB578R

Fixation
for GD674, GD676, GD678
56 mm



GB689R

Fixation
for GD672, GD673
56 mm

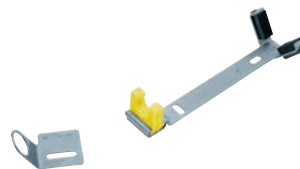

GB580R

Fixation
for GD682, GD681
56 mm



GB587R

Fixation
for GD685
56 mm



GB586R

Fixation
for GD675
56 mm



Mechanical Reprocessing

ELAN EC

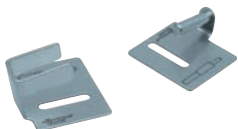

GB680R

Fixation
for GA173, GA176
56 mm



HiLAN XS/HiLAN



GB577R

Fixation
for pneumatic Aesculap motors
with mounted angled hose adaptor
GA508R
56 mm

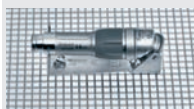

GB610R

Fixation
for GA740R, GA741R
56 mm

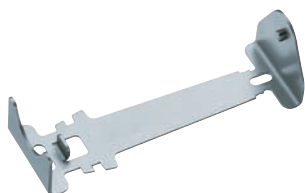
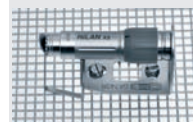

GB609R

Fixation
for GA742R, GA522R
56 mm

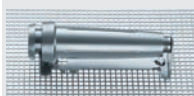

microLAN

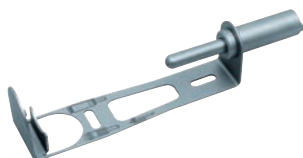

GB685R

Fixation

for GA502, GA553, GA554, GD657, GD658

106 mm



Acculan 3Ti



GB495R

Fixation

for GA671, GA672, GA673, GA674, GA871, GA873, GA874

106 mm



GB496R

Fixation

for GB630R, GB634R, GB635R, GB636R, GB637R, GB638R, GB643R, GB644R, GB645R, GB654R, GB655R, GB656R, GB658R, GB660R

106 mm



GB497R

Fixation

for GB630R, GB634R, GB635R, GB636R, GB637R, GB638R, GB643R, GB644R, GB645R, GB654R, GB655R, GB656R, GB658R, GB660R

106 mm



GB487R

Fixation

for GA675

56 mm



Mechanical Reprocessing



GB488R

Fixation
for GA678
76 mm



GB489R

Fixation
for GA614, GA644, GA679
106 mm



GB498R

Fixation
for GA668, GA670, GA870
106 mm

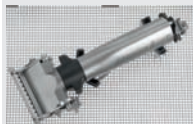

Acculan 3Ti Electro



GB485R

Fixation
for GA875
56 mm



GB486R

Fixation
for GA878
56 mm



Hi-Line XS



GB611R

Fixation for 1 Hi-Line XS handpiece

for GB740R, GB751R, GB752R, GB753R, GB756R, GB757R, GB758R, GB771R, GB772R, GB773R

56 mm

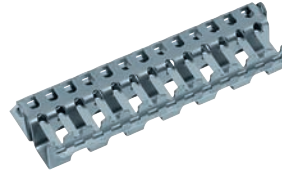

GB613R

Fixation

for 13 burrs of the Hi-Line XS, Hi-Line or 2,35 mm shaft range

36 mm

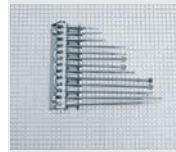

GB614R

Fixation for 3 Hi-Line XS handpieces

for GB740R, GB751R, GB752R, GB753R, GB756R, GB757R, GB758R, GB771R, GB772R, GB773R

56 mm

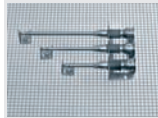

GB615R

Fixation

for GB741R - GB748R

56 mm

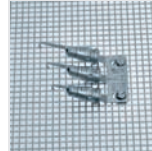

Hi-Line XXS



GB605R

Fixation for 1 Hi-Line XXS handpiece

for GB790R

56 mm



GB606R

Fixation for 2 Hi-Line XXS shafts

for GB791R, GB792R, GB793R, GB794R

56 mm



Mechanical Reprocessing



GB696R

Cleansing device for 4 Hi-Line XXS shafts
not suitable for autoclaving

micro-Line



GB681R

Fixation
for GB109, GB110, GB111, GB112, GB113, GB114R, GB291R, GB292R, GD305, GD307, GB310, GD450M, GD451M, GD452M, GD455M, GD456M, GD457M, GD465M, GD466M, GD467M

56 mm



GB682R

Fixation
for GB128R, GB129, GB130R, GB166R, GB169R, GB200, GB231R, GB265R, GB267R, GB268R, GB280, GB801R

76 mm



GB686R

Fixation
for GB266, GB298, GB436R

56 mm



mini-Line

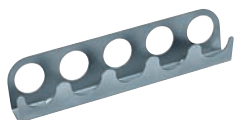

GB673R

Fixation

for GB373R, GB374R, GB376R,
GB377R, GB379R, GB380R,
GB381R, GB382R, GB383R,
GB386R, GB390R, GB391R

56 mm



GB674R

Fixation

for GB385R, GB388R, GB389R,
GB392R, GB397R, GB398R

56 mm



Mechanical Reprocessing

Skin graft mesher

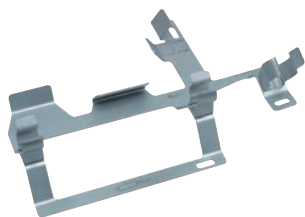

GB688R

Fixation
for BA720R
☞ 106 mm

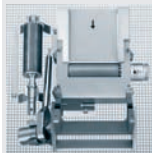

Shaver tips



GB584R

Fixation
for Aesculap shaver tips with diam.
4.5; 5.5 and 6.0 mm
☞ 56 mm

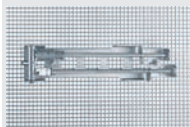

GB585R

Fixation
for Aesculap shaver tips with diam.
3.7 mm
☞ 56 mm

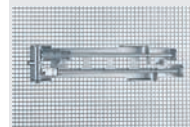

Accessories



GB564R

Fixation
for GA505R, GA513R, GA523R
☞ 56 mm



GB463R

Fixation
for GA460R, GA464R, GA466R
☞ 76 mm





GB575R

Fixation
for GA506R
76 mm



GB576R

Fixation
for GA507R
56 mm



GB480R

Fixation
for GA468R
76 mm

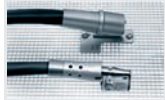

GB467R

Fixation
for GB421R, GB422R, GB423R,
GB424R, GB425R
56 mm



GB474R

Fixation
for GA206R
56 mm



GB481R

Fixation
for saw blades and other
accessories
56 mm

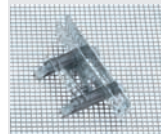

Mechanical Reprocessing



GB572R

Fixation

for GB300R - GB308R

≡ 56 mm

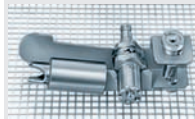

GB690R

Fixation

for GB173R, GB119, GB154, GB194,
GB628R, GA031201, GB424201,
GA437224, GB009C

≡ 36 mm



GB459R

Mounting kit

Acculan 3Ti

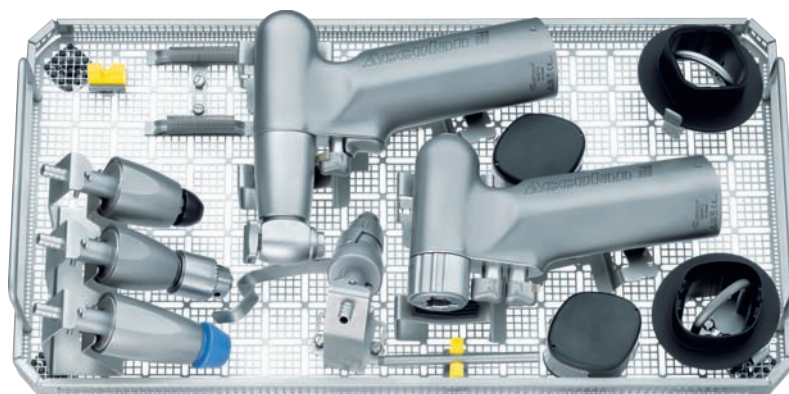

GB243R

Storage System for 2 Acculan 3Ti machines

106 mm
 consisting parts:
 GB243800
 GB481R
 GB487R
 GB488R
 GB495R
 GB496R
 GB497R
 GB690R

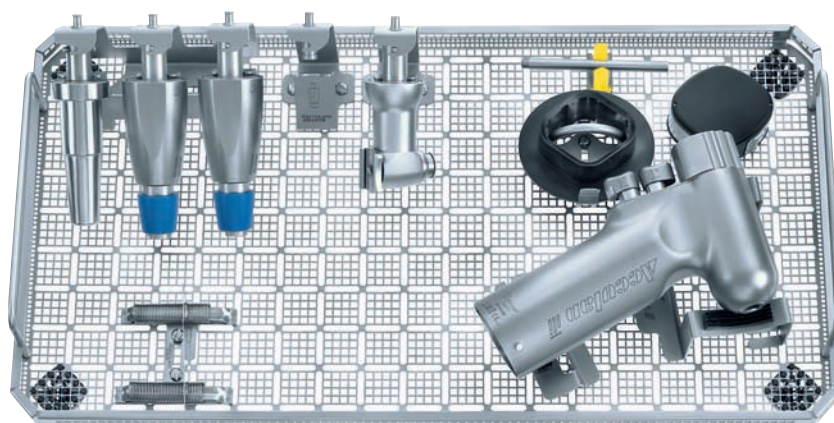

GB244R

Storage System for 1 Acculan 3Ti machine

106 mm
 consisting parts:
 GB243800
 GB481R
 GB487R
 GB488R
 GB495R
 GB496R
 GB497R
 GB690R

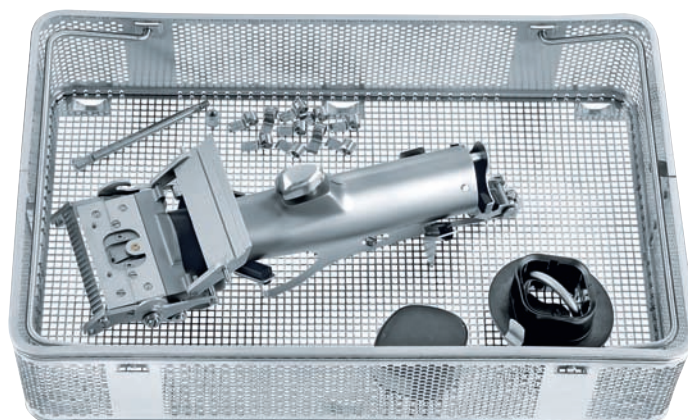

GB256R

Storage System for Acculan 3Ti dermatome

106 mm
 consisting parts:
 GB487R
 GB488R
 GB498R
 JC254R

Mechanical Reprocessing

microspeed uni

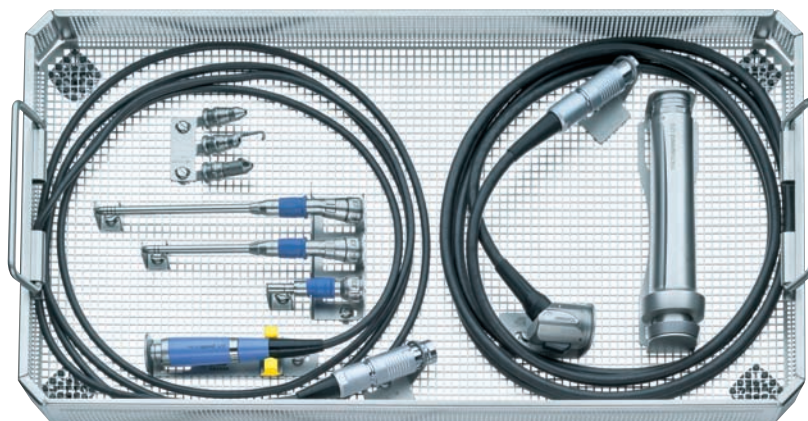

GB255R

Storage System for microspeed uni

Neurosurgery

56 mm

consisting parts:

GB586R

GB587R

GB614R

GB615R

GB689R

JF212R

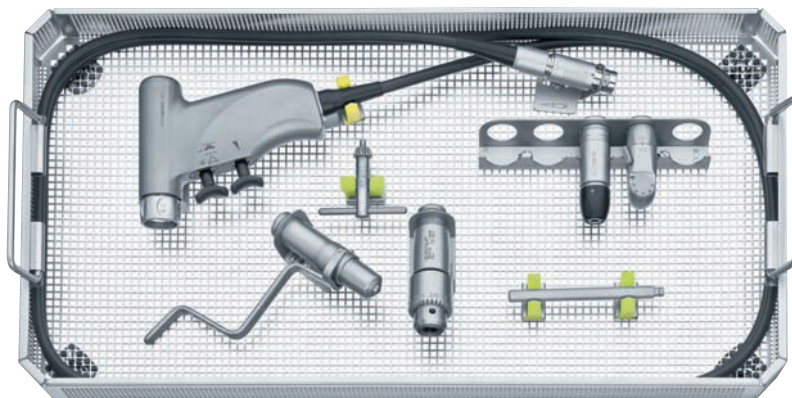

GB254R

Storage System for microspeed uni

small bone surgery

56 mm

consisting parts:

GB579R

GB673R

GB674R

GB690R

JF212R

microspeed arthro

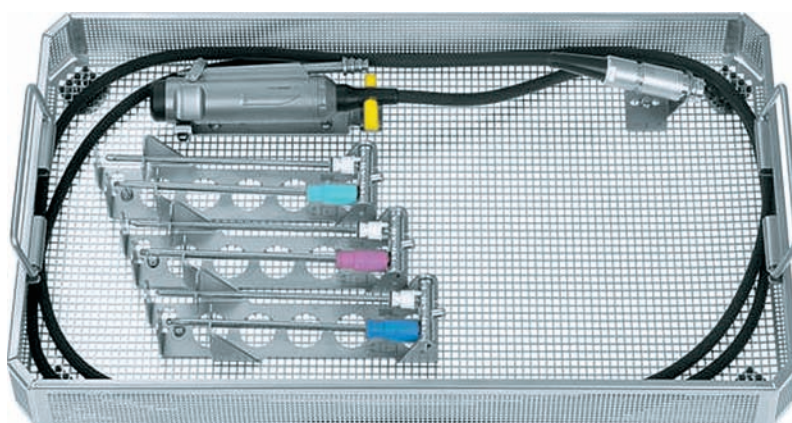

GB253R

Storage System for microspeed arthro

56 mm

consisting parts:

GB580R

GB584R

JF212R

HiLAN XS

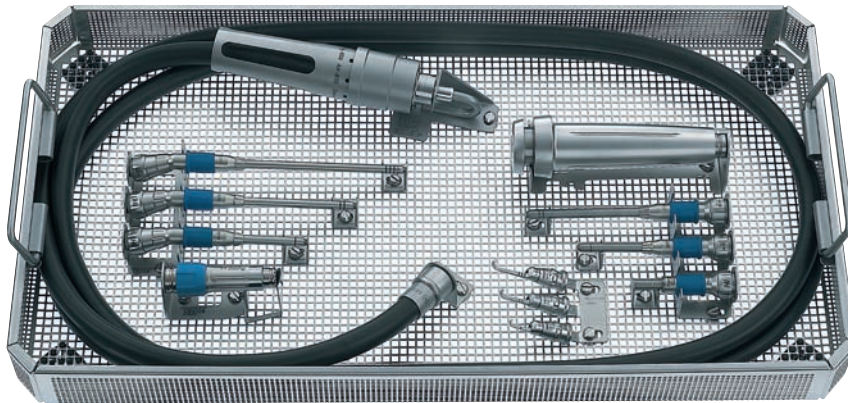

GB252R

Storage System for HiLAN XS

56 mm

consisting parts:

GB564R

GB609R

GB610R

GB614R

GB615R

JF212R

Notes

Index

Index by reference numbers

BA720R	57	GA676	29	GB254R	74	GB600810	60
BA725R	57	GA677	28	GB255R	74	GB600820	60
		GA678	18, 29	GB256R	73	GB600830	60
GA031R	56	GA679	29	GB265R	42	GB600840	60
GA059	61	GA740R	23	GB268R	43	GB600870	60
GA062R	56	GA742R	23	GB292	43	GB605R	67
GA087	51	GA830	21	GB373R	44	GB606R	67
GA088C	52	GA835	21	GB374R	45	GB609R	64
GA091C	52	GA870	17	GB376R	44	GB610R	64
GA099	51	GA871	17	GB377R	44	GB611R	67
GA173	21	GA873	17	GB382R	44	GB613R	67
GA176	21	GA874	17	GB383R	44	GB614R	67
GA186209	56	GA875	18	GB390R	45	GB615R	67
GA187R	45, 55	GA876	18	GB391R	45	GB628R	54
GA188	21	GA877	17	GB392R	45	GB630R	25
GA194R	51	GA878	18	GB398R	44	GB634R	26
GA195R	51			GB421R	54	GB635R	25
GA206R	52	GB007R	55	GB422R	54	GB636R	25
GA208	52	GB020R	56	GB423R	54	GB637R	25
GA391	53	GB040	58	GB425R	54	GB638R	26
GA391SU	53	GB041R	58	GB426R	54	GB643R	26
GA392SU	53	GB042R	58	GB436R	17, 28	GB645R	26
GA411	46	GB043R	58	GB459R	72	GB654R	26
GA415	46	GB044R	58	GB463R	70	GB655R	26
GA460R	49	GB046	58	GB467R	71	GB656R	27
GA461R	50	GB106R	42	GB474R	71	GB658R	27
GA463R	50	GB109	38	GB480R	71	GB660R	27
GA464R	49	GB111	40	GB481R	71	GB673R	69
GA465R	50	GB119	40	GB485R	66	GB674R	69
GA466R	49	GB128R	41	GB486R	66	GB680R	64
GA468R	50	GB129	41	GB487R	65	GB681R	68
GA505R	48	GB130R	41	GB488R	66	GB682R	68
GA506R	49	GB141	57	GB489R	66	GB685R	65
GA507R	48	GB164	40	GB495R	65	GB686R	68
GA508R	52	GB169R	42	GB496R	65	GB688R	70
GA513R	48	GB171N	57	GB497R	65	GB689R	63
GA521	51	GB173	40	GB498R	66	GB690R	72
GA523R	48	GB182R	55	GB564R	70	GB696R	68
GA526P	53	GB184R	55	GB572R	72	GB740R	35
GA529	23	GB187R	55	GB575R	71	GB741R	35
GA530	53	GB200	41	GB576R	71	GB742R	35
GA553	23	GB222	41	GB577R	64	GB743R	35
GA666	29	GB223	41	GB578R	63	GB744R	36
GA668	27	GB224	42	GB579R	63	GB745R	36
GA670	28	GB227R	42	GB580R	63	GB746R	35
GA671	25	GB231R	42	GB584R	70	GB747R	35
GA672	25	GB243R	73	GB585R	70	GB748R	36
GA673	27	GB244R	73	GB586R	63	GB751R	32
GA674	28	GB252R	75	GB587R	63	GB752R	32
GA675	29	GB253R	74	GB600	60	GB753R	32

Index by reference numbers

GB756R	33			
GB757R	33			
GB758R	33			
GB771R	34			
GB772R	34			
GB773R	34			
GB790R	37			
GB791R	37			
GB792R	37			
GB793R	37			
GB794R	37			
GC523R	57			
GD305	40			
GD307	40			
GD372206	56			
GD412804	46			
GD416M	46			
GD450M	38			
GD451M	38			
GD455M	39			
GD456M	39			
GD457M	39			
GD665	13			
GD668	9			
GD670	9			
GD671	9, 13			
GD672	9, 13			
GD673	9, 13			
GD674	10, 14			
GD675	10			
GD676	9			
GD678	10, 14			
GD681	10, 13			
GD682	11, 13			
GD684	10, 14			
GD685	10			
TE472	56			
TE730	47			
TE734	47			
TE735	47			
TE780	47			
XF457R	55			

Overview tool attachments

AO big

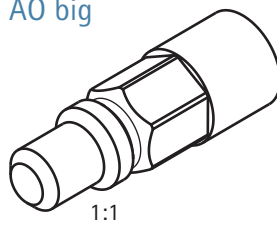

AO small

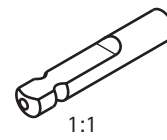

Dental

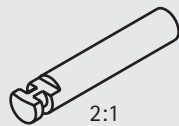

DIN

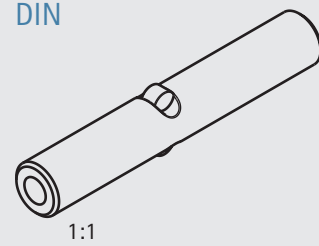

Harris

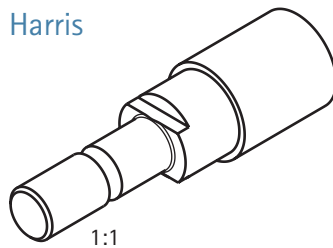

Hudson

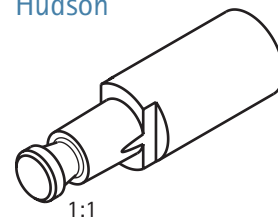

Hexagon

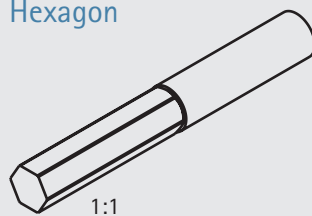

Synthes DHS/DCS

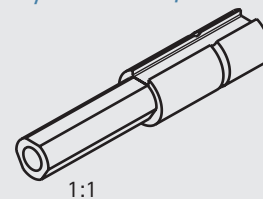



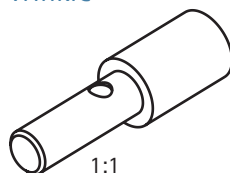



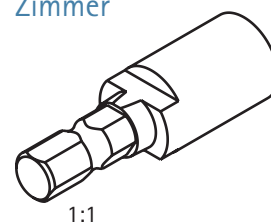





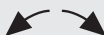

Trinkle



Zimmer

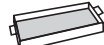

Signs and symbols

	Latex-free all products listed in this catalogue are latex-free
	Article code fixation
	Forward / reverse drive
	Forward drive
	Oscillation frequency
	Oscillation angle
	Stroke
	Cannulation
	Cable length
	Weight
	Sterile
	Single use
	Packaging Unit
	Required height of tray
	Suitable handpiece-line

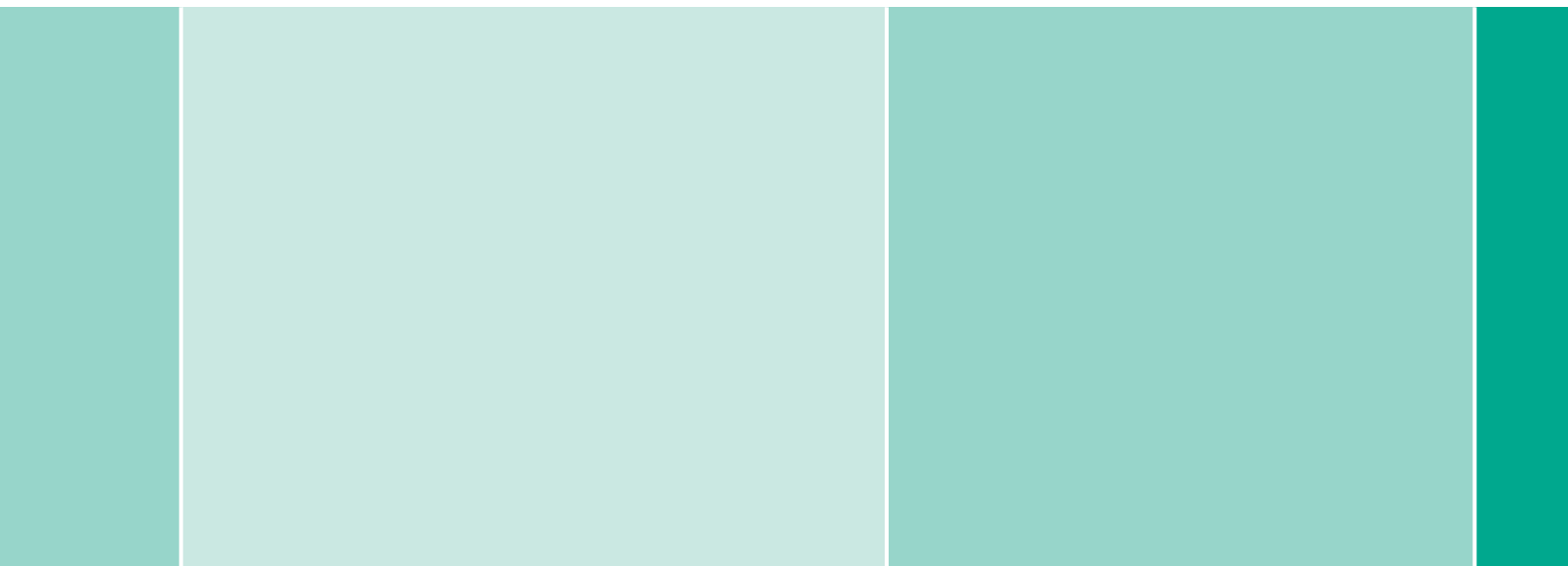

Aesculap AG | Am Aesculap-Platz | 78532 Tuttlingen | Germany
Phone +49 7461 95-0 | Fax +49 7461 95-26 00 | www.aesculap.com

Aesculap – a B. Braun company

The main product trademark 'Aesculap' is a registered trademark of Aesculap AG.

Subject to technical changes. All rights reserved.
This brochure may only be used for the exclusive purpose of obtaining information about our products. Reproduction in any form partial or otherwise is not permitted.

Brochure No. 022702

0913/3/5